

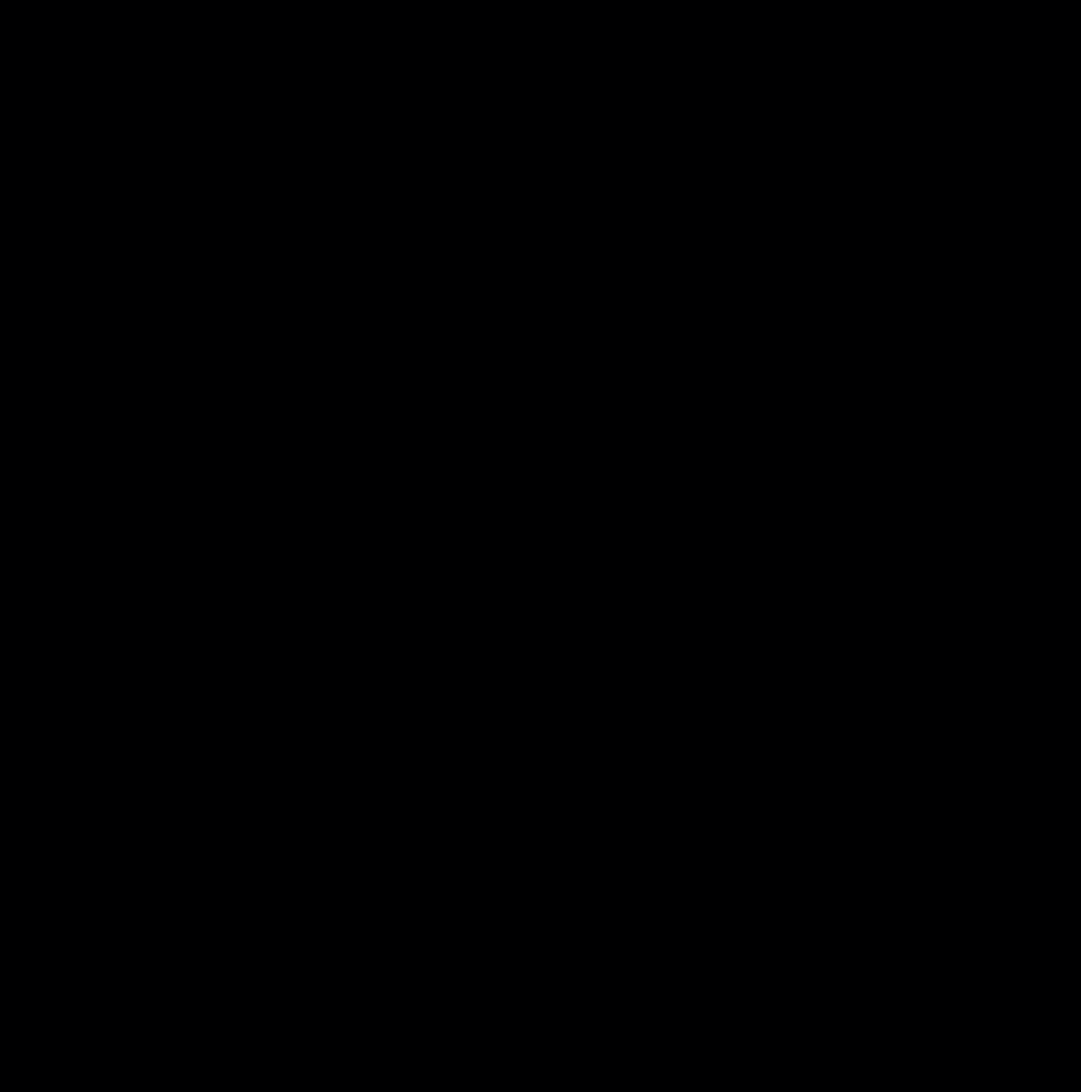

APEXFINE

invisible luxury by Ponzio





APEXFINE
invisible luxury by Ponzio

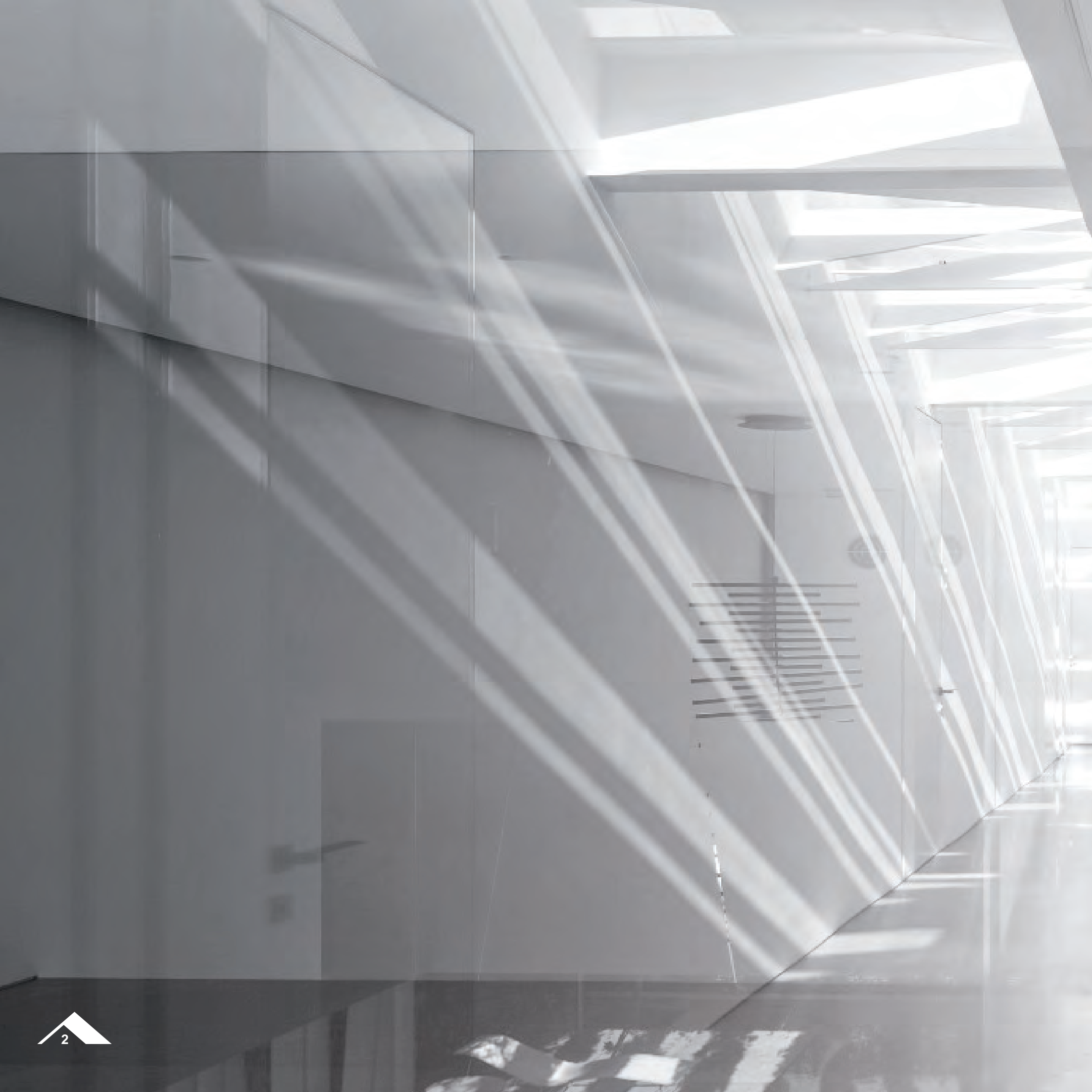

Descrizione prodotto

I serramenti Apexfine sono caratterizzati da grandi vetrate scorrevoli con profili in alluminio di dimensioni notevolmente ridotte. I telai fissi, studiati per l'appoggio dei profili anta, sono invisibili perchè nascosti dietro gli stipiti laterali e superiori, mentre il telaio inferiore è inserito nel pavimento, in modo da evitare qualsiasi ingombro a terra. Questo garantisce una trasparenza e una vista totale verso l'ambiente esterno. Ciononostante, è garantito un isolamento termico ai massimi livelli. Lo scorrimento è ottenuto attraverso l'impiego di un innovativo sistema brevettato da Ponzio. Il sistema di scorrimento è integrato nel telaio inferiore con coppie di ruote in acciaio inox unite da un perno. Queste ultime, poste ad un'interasse di 20 cm e sostenute da un profilo in alluminio, garantiscono elevate capacità di portata e danno la possibilità di inserire anche vetrate isolanti molto pesanti e con vetri temperati, stratificati e/o bassoemissivi. La tenuta all'acqua è assicurata da un falso telaio inferiore, costruito con una vasca di contenimento per accogliere le acque d'infiltrazione che saranno poi drenate verso l'esterno. L'apertura delle vetrate può avvenire manualmente oppure attraverso un sistema motorizzato, mentre le chiusure possono essere dotate di un sistema elettro-meccanico completamente automatico. Il sistema consente la costruzione di serramenti a due o più ante, ante tipo scrigno e ante ad angolo apribile. I serramenti Apexfine rappresentano uno stile architettonico rivoluzionario che si adatta perfettamente ad ogni tipo di ambiente. Infine, le diverse soluzioni tecniche consentono l'installazione dei serramenti Apexfine su nuove costruzioni o su edifici da ristrutturare.

Product description

Apexfine windows are characterized by big sliding glass walls realized with very reduced size aluminium profiles. The fixed frames, suitable to support the wing profiles, are invisible because hidden behind lateral and upper jambs while the lower frame is included into the floor to avoid whichever obstruction on the ground. These features guarantee transparency and a total view towards the external environment. In addition, the thermal insulation is assured to the full. The sliding is obtained by the use of an innovative Ponzio patent system. The sliding system is integrated in the lower frame troughout couples of stainless steel wheels joined by a pivot. The wheels, positioned at 20 cm distance and substained by an aluminium profile, guarantee high weight capacity and allow to insert even very heavy insulating glass walls constituted by tempered and low-emissive glasses. Water resistance is assured by a "false" lower frame, built with a retaining tank to gather infiltration waters that are then outward drained. The glass walls opening can be manual or motorized, while locks can be constituted by a completely automatic electro-mechanic system. The Apexfine system allows to build single or double windows, pocket and openable corner windows. Apexfine windows represent an innovative architectural style able to adapt perfectly to all interior design; the different technical solutions allow to install the Apexfine windows in buildings to renovate and in new ones.

Produktbeschreibung

Apexfine Fenster sind durch große Schiebeglasflächen mit Aluminiumprofilen gekennzeichnet, die sehr geringe Maße aufweisen. Die festen Rahmen, die zur Auflage der Flügelprofile ausgearbeitet wurden, sind unsichtbar, da sie hinter den seitlichen und oberen Pfosten verborgen sind. Der untere Rahmen ist hingegen in den Boden eingelassen, um jedweden Raumbedarf auf dem Boden zu vermeiden. Hierdurch wird komplette Transparenz und eine uneingeschränkte Aussicht auf die Außenumgebung garantiert. Dennoch ist Wärmeisolierung auf höchstem Niveau gewährleistet. Der Schiebemechanismus basiert auf dem Einsatz eines innovativen, von Ponzio patentierten Systems. Das Schiebesystem ist im unteren Rahmen mit Räderpaaren aus Edelstahl, die durch einen Bolzen zusammengehalten werden, integriert. Die Räder sind im Abstand von 20 cm zueinander angebracht und werden durch ein Aluminiumprofil gehalten. Sie garantieren hohe Tragfähigkeit und bieten die Möglichkeit, auch sehr schwere isolierende Fensterscheiben aus gehärtetem Glas, Verbundglas und/oder Glas mit Niedrigemission einzusetzen. Die Wasserdichtigkeit ist durch einen falschen unteren Rahmen gewährleistet, der über ein Sammelbecken verfügt, um eingesickertes Wasser aufzufangen, das dann nach außen abgeleitet wird. Die Fenster können manuell oder mit einem motorisierten System geöffnet werden, während sie zum Verschließen mit einem vollkommen automatischen elektromechanischen System ausgestattet werden können. Das System gestattet den Bau von Fenstern mit zwei oder mehreren Flügeln, mauerinternen Flügeln und Eckfenstern, deren Flügel geöffnet werden können. Apexfine Fenster stehen für einen revolutionären architektonischen Stil, der sich an alle Umgebungen perfekt anpasst. Die unterschiedlichen technischen Lösungen gestatten es schließlich, Apexfine Fenster sowohl in Neubauten als auch in Gebäuden zu installieren, die renoviert werden müssen.









Sistema brevettato

Il sistema Apexfine è caratterizzato da telai fissi, studiati per l'appoggio dei profili anta, invisibili perchè nascosti dietro gli stipi laterali e superiori, mentre il telaio inferiore è inserito nel pavimento; su quest'ultimo sono alloggiati coppie di ruote in acciaio inox poste ad un'interasse di 20 cm e sostenute da un profilo in alluminio. Un falso telaio inferiore, costruito con una vasca di contenimento, consente di accogliere le acque d'infiltrazione che saranno poi drenate verso l'esterno. Il carter è ispezionabile per consentire la manutenzione e la pulizia del telaio inferiore.

Patented system

Apexfine system is characterized by fixed frames to lean wing profiles that are invisible because hidden behind lateral and upper jambs; on the lower frame, included into the floor, are couples of stainless steel wheels positioned at 20 cm distance and sustained by an aluminium profile. A "false" lower frames is built with a retaining tank to gather infiltration waters that are outward drained later.

Patentiertes System

Das Apexfine-System ist durch feste Rahmen gekennzeichnet, die zur Auflage der Flügelprofile entwickelt wurden. Sie sind unsichtbar, da sie hinter den seitlichen und oberen Pfosten verborgen sind, während der untere Rahmen im Boden eingelassen ist; auf diesem sind Räderpaare aus Edelstahl im Abstand von 20 cm zueinander untergebracht, die durch ein Aluminiumprofil gestützt werden. Ein falscher unterer Rahmen, der über ein Sammelbecken verfügt, gestattet das Auffangen von eingesickertem Wasser, das in der Folge nach draußen abgeleitet wird. Das Gehäuse kann inspiziert werden, damit der untere Rahmen gewartet und gereinigt werden kann.

Telaio inferiore con coppie di ruote in acciaio inox.

Lower frame with couples of stainless steel wheels.

Unterer Rahmen mit Räderpaaren aus Edelstahl.

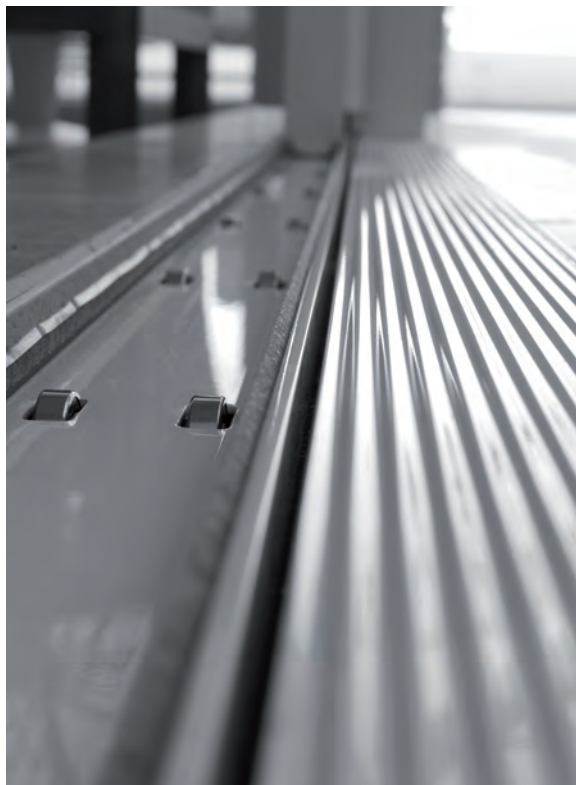

Disegni tecnici

Technical drawing

Technische Zeichnungen

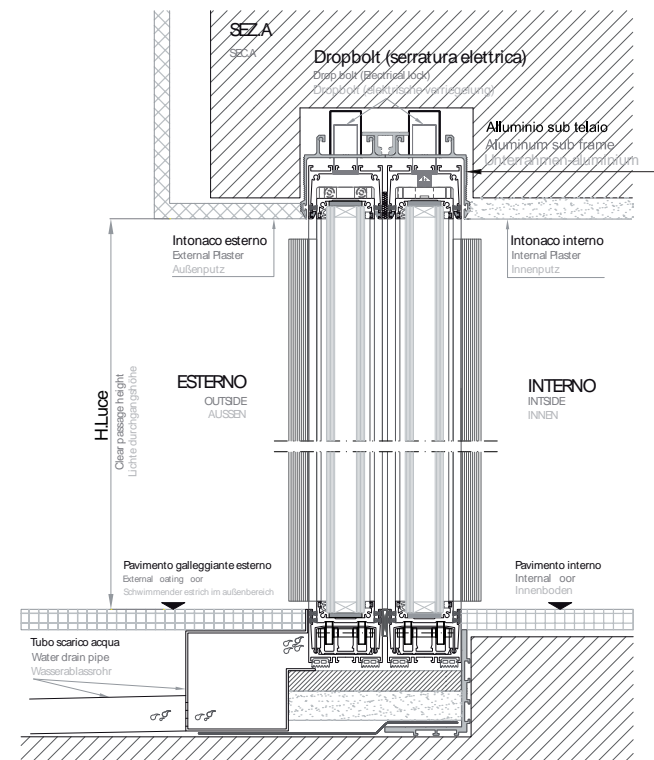
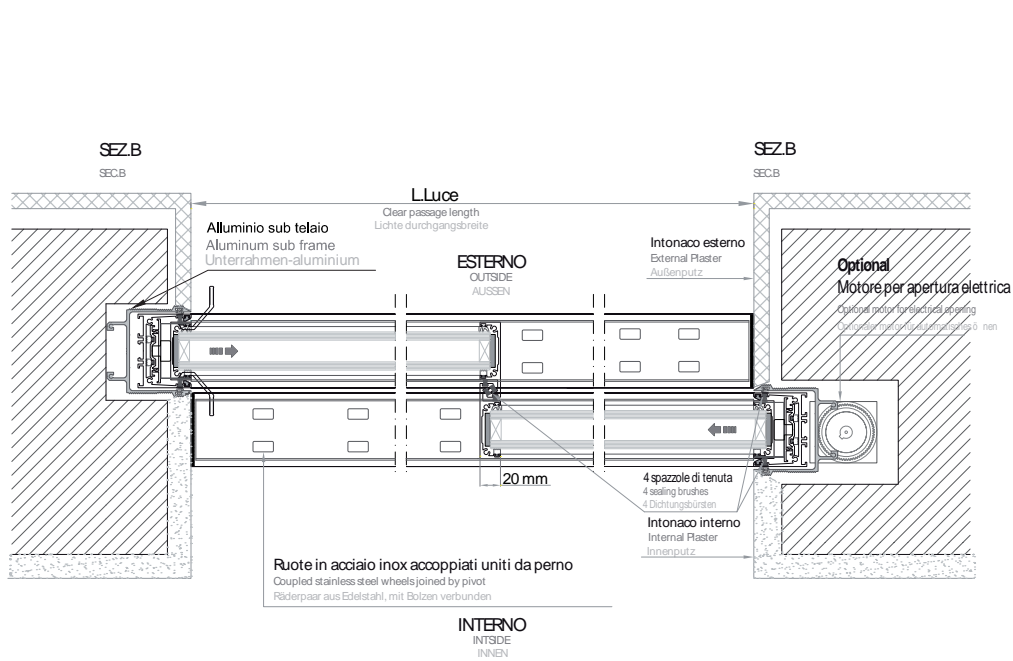
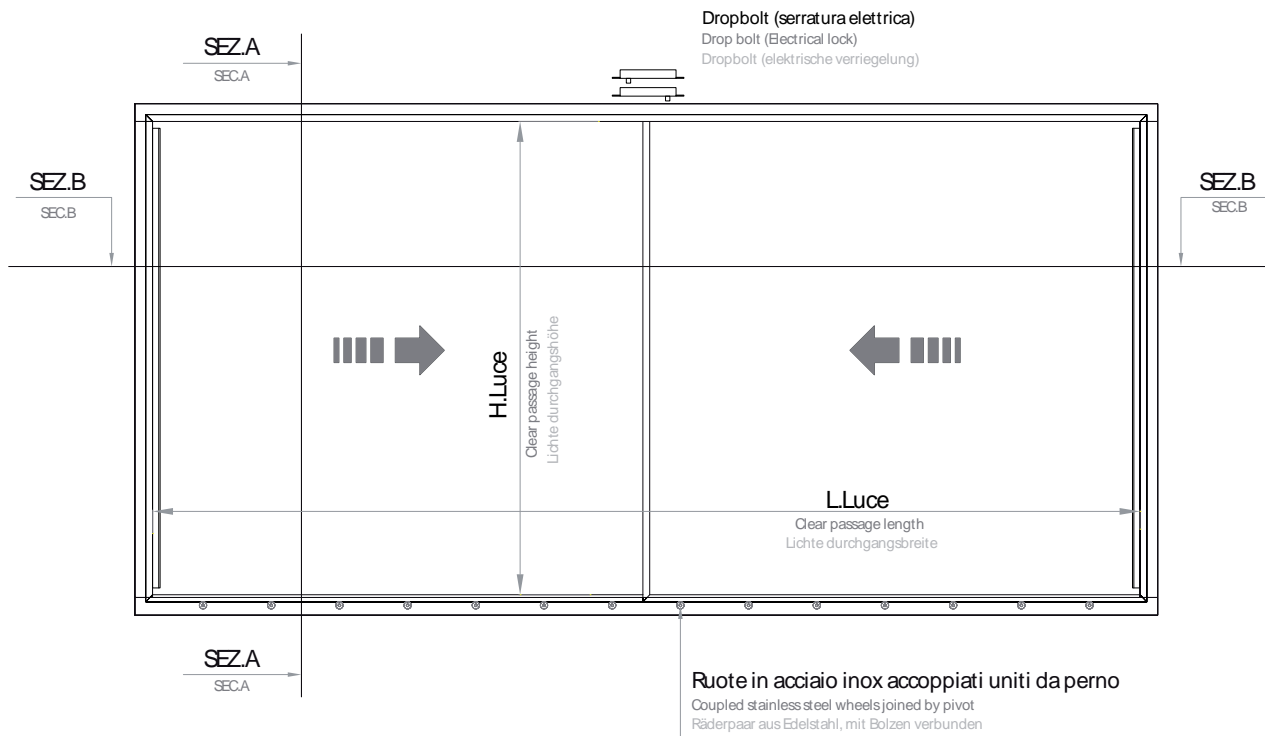





















Caratteristiche tecniche

PESO DELL'ANTA 450 Kg

Esecuzioni a progetto fino a Kg 1000

CHIUSURE

✓ Elettrica con Drop Bolts (catenacci magnetici)

✓ Manuale

MOVIMENTAZIONI

Manuale o automatizzata con gestione computerizzata di movimento e chiusura.

PRESTAZIONI

* Calcolato su dimensione infisso L 3000 x H2700 mm a 2 ante / Calculated on a frame size L 3000 x H2700 mm a 2 doors / berechnet für blendrahmen mit den abmessungen l 3000 x h 2700 mm 2-flügelig

Trasmittanza termica

(con vetro Ug = 1.0 Canalina Calda)

* **UW = 1,48 W/m²K**

Permeabilità all'aria

** **CLASSE 4**

Tenuta all'acqua

** **E750**

Resistenza al carico del

vento

** **B1**

** Calcolato su dim. L 4100 x H 3900 mm a 2 ante

Dim. L 4100 x H3900 mm a 2 doors / Berechnet auf die abmessungen l 4100 x h 3900 mm 2-flügelig

PERFORMANCES

Thermal transmittance

(with glass Ug = 0.18 Plastic Spacer)

† **UW = 0.26 Btu/hft²°F**

Air permeability

** **CLASS 4**

Water resistance

** **E750**

Wind load resistance

B1

LEISTUNGEN

Wärmedurchgang

(mit Glas Ug = 1.0 Warme Kante)

* **UW = 1,48 W/m²K**

Luftdurchlässigkeit

** **KLASS 4**

Wasserdichtheit

** **E750**

Windlastwiderstand

** **B1**

FINITURE / SURFACE FINISHES / VERARBEITUNGEN



Anodizzato colorato
Coloured anodized finish
Anodisiert farbig



Effetto legno
Wood - effect finish
Holzeffekt



Sublimato con effetti speciali anche in 3D
Sublimated finish with special 3D effects
Sublimiert mit spezialeffekten, auch in 3D



Verniciati lucidi e opachi
Gloss and matt ral powder-coated finish
Glanz- und mattlackierung



Verniciato speciale
Special powder - coated finish
Speziallackierung



Effetto legno garantito
Guaranteed wood - effect finish
Garantierter holzeffekt



Ossidati e verniciati, con effetti cromati speciali come metallizzati, bugnati e rustici.
Oximized and powder-coated finish, with special chrome effects, like metallic, rustic and shaped.
Oxidiert und lackiert, mit speziellen Farbeffekten wie Metallic, bossiert und rustikal.

Technical features

RECOMENDED WING WEIGHT 450 Kg

Maximum wing weight Kg 1000

LOCKS

✓ Electrical with Drop Bolts

✓ Manual

MOVEMENTS

Manual or electrical with movement and locking computerized management.

Technische daten

GEWICHT FLÜGEL 450 Kg

Ausführungen nach Entwurf bis zu 1000 kg

VERSCHLUSSSYSTEME

✓ Elektrisch mit DropBolts (Magnetriegel)

✓ Manuell

BETÄTIGUNGSARTEN

Manuell oder automatisch mit computerisierter handhabung von bewegung und verschließen.











APEXFINE ++ thermal break

Caratteristiche tecniche

PESO DELL'ANTA 450 Kg
Esecuzioni a progetto fino a Kg 1000

CHIUSURE

- ✓ Elettrica con Drop Bolts (catenacci magnetici)
- ✓ Manuale

MOVIMENTAZIONI

Manuale o automatizzata con gestione computerizzata di movimento e chiusura.

Technical features

RECOMENDED WING WEIGHT 450 Kg
Maximum wing weight Kg 1000

LOCKS

- ✓ Electrical with Drop Bolts
- ✓ Manual

MOVEMENTS

Manual or electrical with movement and locking computerized management.

Technische daten

GEWICHT FLÜGEL 450 kg
Ausführungen nach entwurf bis zu 1000 kg

VERSCHLUSSSYSTEME

- ✓ Elektrisch mit DropBolts (Magnetriegel)
- ✓ Manuell

BETÄTIGUNGSARTEN

Manuell oder automatisch mit computerisierter handhabung von bewegung und verschließen.

PRESTAZIONI / PERFORMANCES

* Calcolato su dimensione infisso L 3000 x H2700 mm a 2 ante / Calculated on a frame size L 3000 x H2700 mm a 2 doors / Berechnet für blendrahmen mit den abmessungen L 3000 x H 2700 mm 2-flügelig

Trasmittanza termica (con vetro Ug = 0,6 Canalina Calda)	Permeabilità all'aria	Tenuta all'acqua	Resistenza al carico del vento
* UW = 0,79 W/m²K	** CLASSE 4	** E750	** B1
Thermal transmittance (with glass Ug = 0,11 Plastic Spacer)	Air permeability	Water resistance	Wind load resistance
* UW = 0.14 Btu/hft²°F	** CLASSE 4	** E750	** B1
Wärmedurchgang (mit Glas Ug = 0,6 Warme Kante)	Luftdurchlässigkeit	Wasserdichtheit	Windlastwiderstand
* UW = 0,79 W/m²K	** KLASSE 4	** E750	** B1

** Calcolato su dim. L 4100 x H 3900 mm a 2 ante
Dim. L 4100 x H3900 mm a 2 doors / Berechnet auf die Abmessungen L 4100 x H 3900 mm 2-flügelig

FINITURE / SURFACE FINISHES / VERARBEITUNGEN



Anodizzato colorato
Coloured anodized finish
Anodisiert farbig



Effetto legno
Wood - effect finish
Holzeffekt



Sublimato con effetti speciali anche in 3D
Sublimated finish with special 3D effects
Sublimiert mit spezialeffekten, auch in 3D



Verniciati lucidi e opachi
Gloss and matt ral powder-coated finish
Glanz- und mattlackierung



Verniciato speciale
Special powder - coated finish
Speziallackierung



Effetto legno garantito
Guaranteed wood - effect finish
Garantierter holzeffekt



Ossidati e verniciati, con effetti cromati speciali come metallizzati, bugnati e rustici.
Oximized and powder-coated finish, with special chrome effects, like metallic, rustic and shaped.
Oxidiert und lackiert, mit speziellen Farbeffekten wie Metallic, bossiert und rustikal.

Disegni tecnici

Technical drawing

Dessins techniques

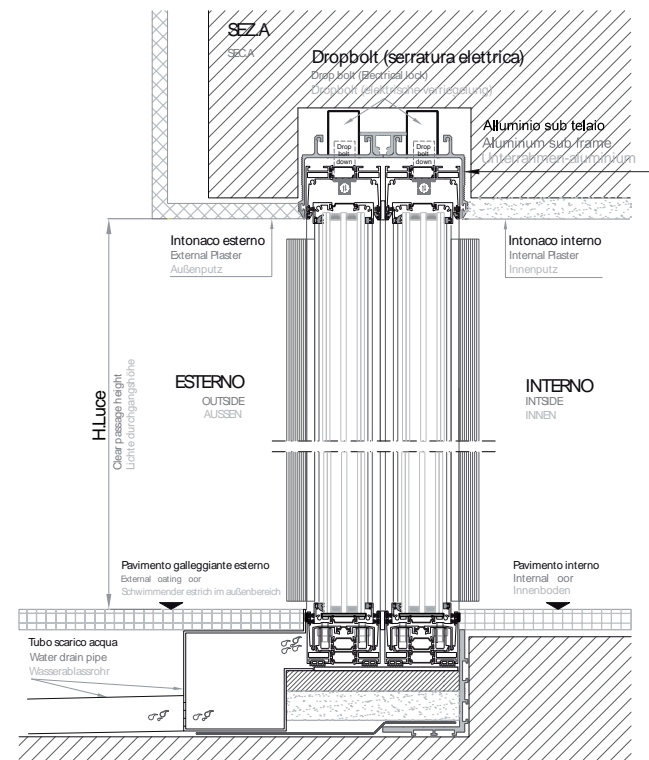
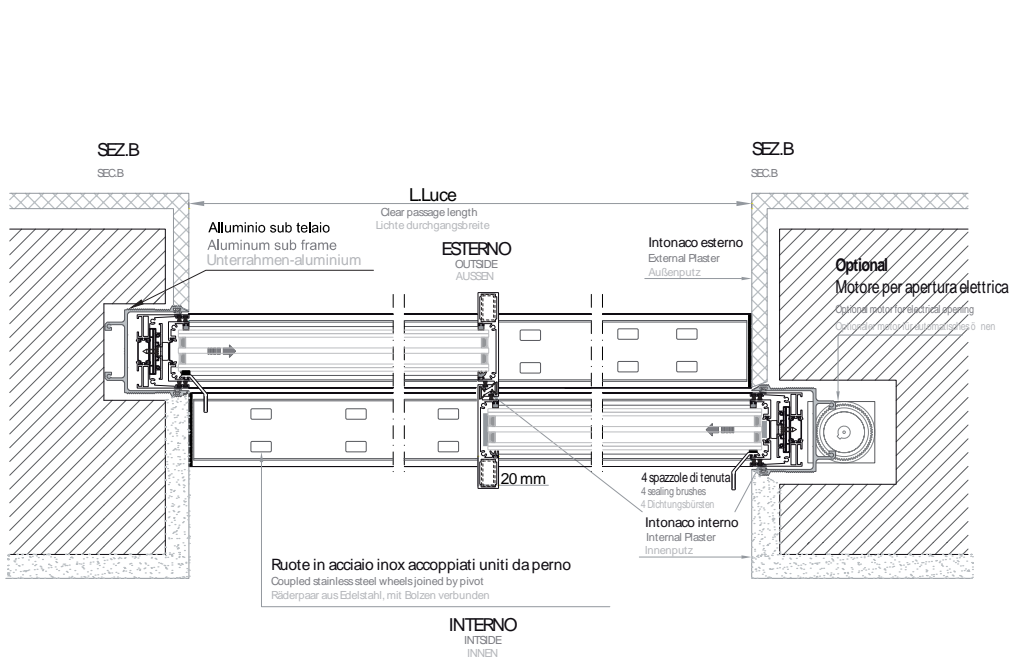
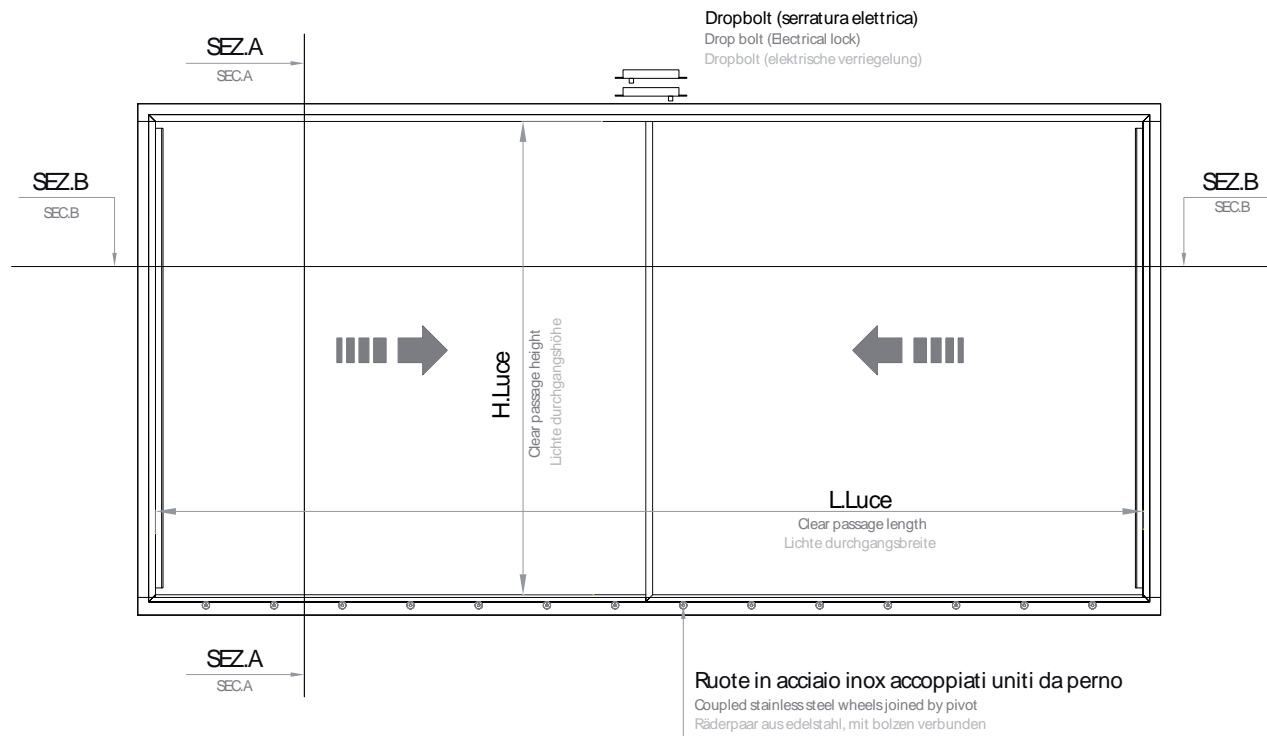





Chiusura manuale

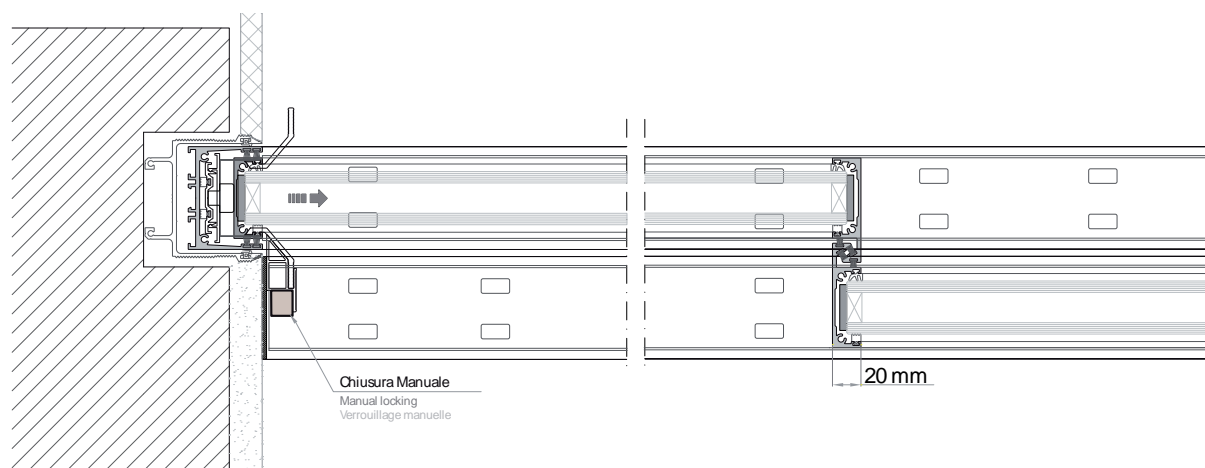

La chiusura manuale consiste in una presa installata unicamente all'interno dell'Apexfine, formata da elementi in alluminio con alcuni particolari in acciaio inox. La chiusura ha un sistema di anti-rottura che permette la sua movimentazione, anche in caso di apertura, evitando danni al meccanismo, il quale è stato sottoposto a severi test di qualità resistendo a 150.000 cicli di apertura e chiusura, senza riportare nessun danno. La chiusura manuale ha delle dimensioni molto ridotte e può essere installata anche su serramenti Apexfine esistenti, perchè integrata sulla maniglia di trascinamento; in questo modo il design dell'Apexfine non subisce nessun tipo di variazione, con l'importante vantaggio di essere in alluminio e quindi sempre in tinta con le ante Apexfine.

Manual locking

The new manual locking consists of a small handle which is directly installed inside the Apexfine window; it is composed of aluminium and stainless steel special parts. The locking is equipped with a break-proof system which allows functioning, also in an opening position and avoiding damages to the mechanism, which has been strictly subject to quality tests of 150,000 opening cycles, without any damages. Manual locking has very reduced dimensions and can be installed on an existing Apexfine because integrated to the pulling handle and guaranteeing the same original design and the same finish treatment as for the wings.

Manuelles schließen

Das manuelle Verschlussystem besteht in einer Griffmulde, die ausschließlich innerhalb des Apexfine Fensters installiert ist. Sie ist aus Aluminiumelementen gemacht und weist Einzelteile aus Edelstahl auf. Der Verschlussmechanismus ist mit einem Bruchschutzsystem ausgestattet, das die Betätigung auch beim Öffnen gestattet und Schäden am Mechanismus vermeidet; letzterer wurde strengen Qualitätstests unterzogen, bei denen er 150.000 Öffnungs- und Schließzyklen standhalten musste, ohne dabei Schäden davonzutragen. Das manuelle Verschlussystem ist sehr klein und kann auch auf bereits vorhandenen Apexfine Fenstern installiert werden, da es im Ziehgriff eingebaut ist; auf diese Weise wird das Design des Apexfine Fensters in keiner Weise verändert, mit dem bedeutenden Vorteil, dass das System aus Aluminium ist und daher stets farblich zu den Apexfine-Flügeln passt.

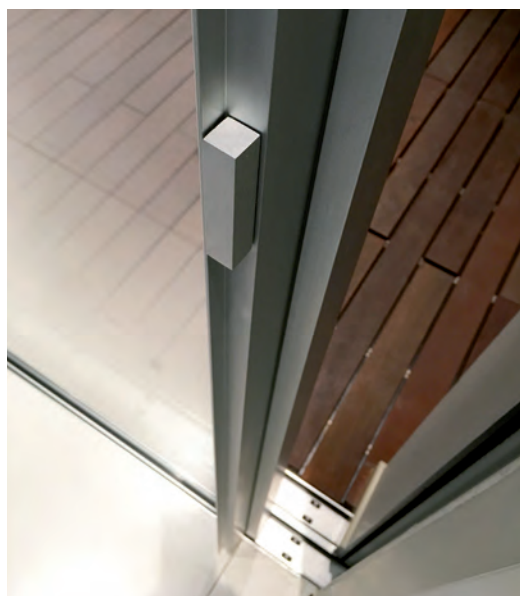





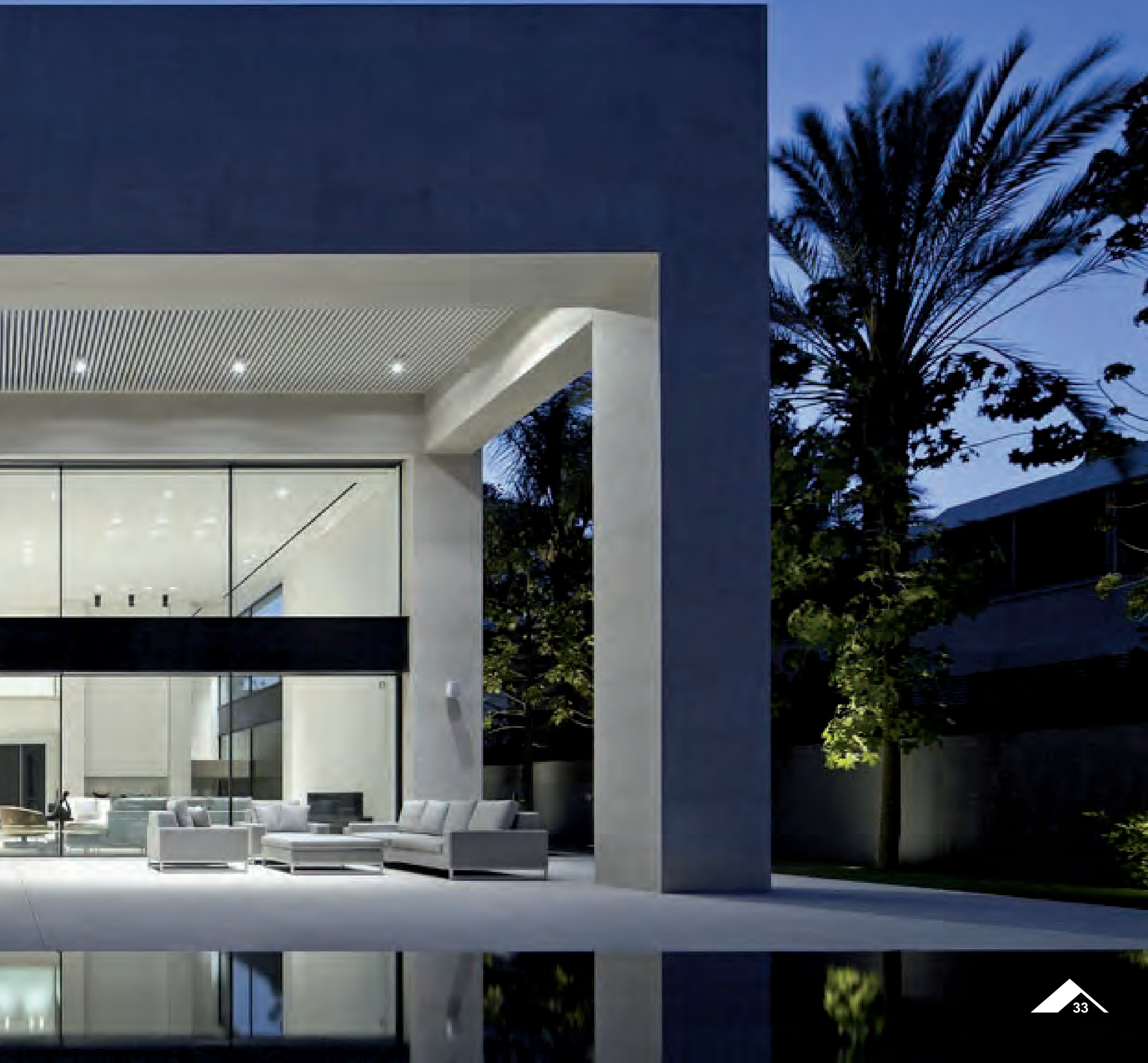







Tipologie

Typologies

Fenstertypen

Il sistema consente la costruzione di serramenti a due o più ante, ante a scomparsa e ante ad angolo apribile.

Apexfine system allows to build single or multiple windows, rollaway and openable corner windows.

Das System gestattet die Anfertigung von Fenstern mit zwei oder mehreren Flügeln, mit Schiebeflügeln und Eckfenstern mit Flügeln, die geöffnet werden können.

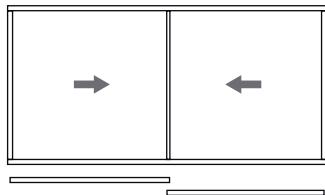

Finestra 2 ante scorrevole
Double sliding window
Fenster 2 schiebeflügel



Finestra 1 anta fissa
Single fixed window
1 fester flügel

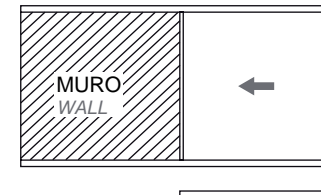

Finestra 1 anta a scricino
Single pocket window
Fenster 1 mauerinterner flügel

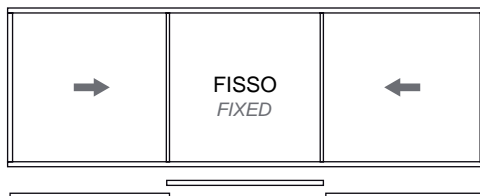

Finestra 3 ante scorrevoli, su 2 binari
Triple sliding window on 2 tracks
Fenster 3 schiebeflügel, auf 2 schienen

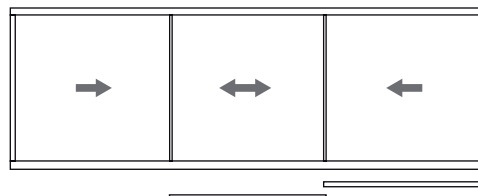

Finestra 3 ante scorrevoli, su 3 binari
Triple sliding window on 3 tracks
Fenster 3 schiebeflügel, auf 3 schienen

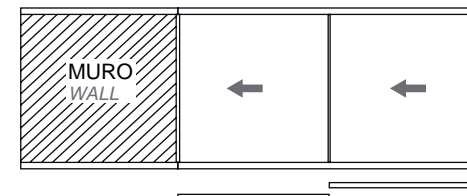

Finestra 2 ante con un'anta a scricino
Double window, with a pocket wing
Fenster 2 flügel, mit einem mauerinternen flügel

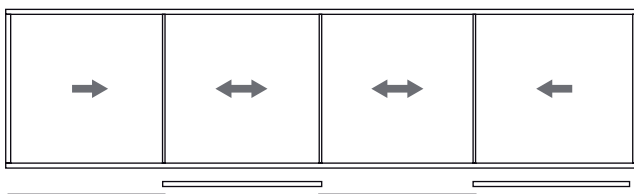

Finestra 4 ante scorrevoli, su 2 binari
Quadruple sliding window on 2 tracks
Fenster 4 schiebeflügel, auf 2 schienen

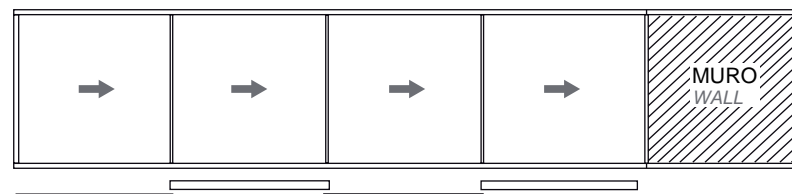

Finestra 4 ante scorrevoli, su 2 binari con 1 anta a scricino
Quadruple sliding window, on two tracks with a pocket wing
Fenster 4 schiebeflügel, auf 2 schienen, mit 1 mauerinternen flügel

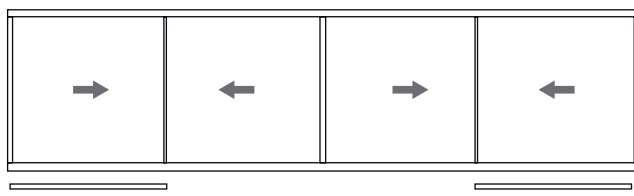

Finestra 4 ante scorrevoli, su 2 binari
Quadruple sliding window on 2 tracks
Fenster 4 schiebeflügel, auf 2 schienen

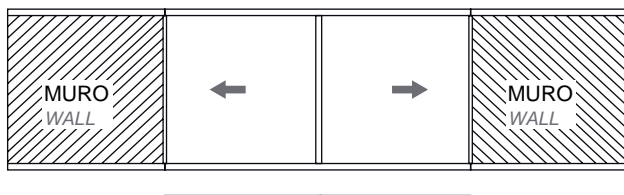

Finestra 2 ante a scricino
Double pocket window
Fenster 2 mauerinterne flügel

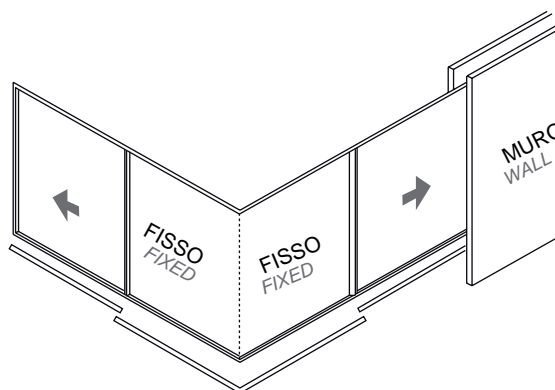

Finestra ad angolo fisso
Fixed corner window
Festes eckfenster

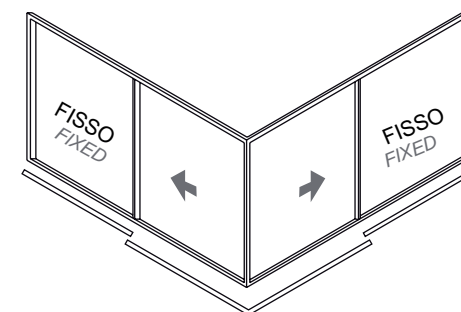

Finestra ad angolo apribile
Openable corner window
Eckfenster, das geöffnet werden kann

NOTA: le tipologie e il numero di ante possono essere infiniti. Il nostro ufficio tecnico è a disposizione per qualsiasi tipo di realizzazione su progetto.

NOTE: we produce various typologies of windows and doors, tailored to customer requirements. Our Technical office is at your disposal for any kind of construction project.

HINWEIS: die flügel können in unzählige arten und anzahlen angefertigt werden. Unser technisches büro steht ihnen für alle anfertigungen nach entwurf zur verfügung.



















APEXFINE
invisible luxury by Ponzio

info@apexfine.com
www.apexfine.com

 **Ponzio**
Aluminium design since 1941

info@ponzioaluminium.com
www.ponzioaluminium.com